



IP65 ZHAGA-BOOK 18 BLE DALI-2 Sensor Controller (With Light Sensor) CLX-SV9033A-PIR-D-BUS (15meter version)

*Support the ELT Function (Need to work with DALI EL Driver)

Features

- Bluetooth to DALI sensor controller
- Bluetooth® NLC Certified
- Mesh network, which has a much longer control distance, transmits received signals to neighboring devices
- All devices on DALI line are broadcast controlled by mobile application
- Supporting our kinetic energy switches and EnOcean switches EWSSB and EWSDB
- Autonomos sensor-based control
- Support sensitivity adjustment, Mesh Network, a better method to deal with false trigger
- ZHAGA Book 18 socket
- Available with Magnetic reset (touch "OPEN" on the sensor top for 5 seconds)*
- On-board antenna
- Waterproof grade: IP65, suitable for outdoor luminaries
- 5 years warranty



* Magnetic Reset

Single-node Control :
≥140m (460ft)

Mesh-range in Between:
Around 70m (Max.230ft)

Parameters

Electrical Information	
Power Supply	DALI BUS
Power Consumption	Max. 30mA
Control	DALI-2
Contact interface	DA-, DA+ (Zhaga Book 18)
Status Indicators	Green(commissioning), Red(motion detection)
Sensing	
Motion Detection	PIR
Daylight Harvesting	YES
Mounting Height	Up to 17m, recommended height: 15m
Detection Angle/Range	360° (ceiling)/18m(Diameter)
Environment	
Operating Temperature Range	-20°C~50°C / -68°F ~122°F
Operating Humidity	0-95%(non-condensing)
Safety Certification	cULus Listed, CE

Dimension

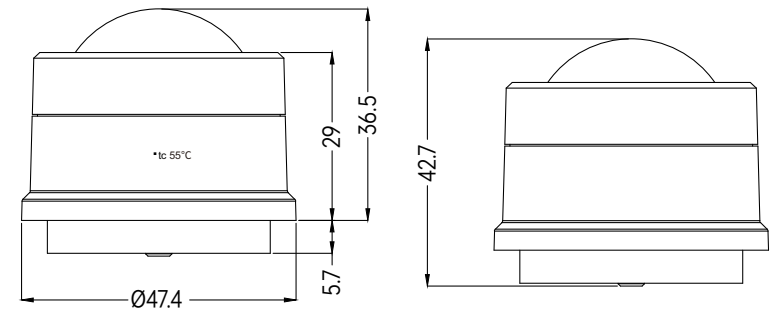



IP65 ZHAGA-BOOK 18 BLE DALI-2 Sensor Controller (With Light Sensor)

CLX-SV9033A-PIR-D-BUS (15meter version)

Product Info

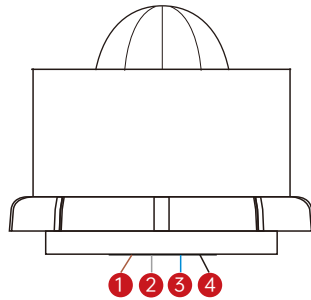

Zhaga Receptacle Accessory(optional for order)

- 1 Port 1 (Brown): No connection
- 2 Port 2 (Gray): GND/ DA- (DALI signal)
- 3 Port 3 (Blue): DA+ (DALI signal)
- 4 Port 4 (Black): No connection

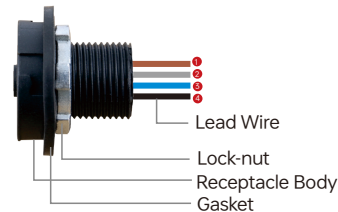

Product Description

- The IP65 motion sensor combines motion sensor and light sensor. The device performs motion detection and measures illuminance level. With standard ZHAGA Book 18 interface socket, the sensor can easily fit into various luminaires with no tools required.
- The result is increased occupant comfort and significant energy savings that meet the most demanding building energy codes. The sensor is IP65 rating, which enables it to be used for outdoor luminaires.

Operation

- Do wiring according to connection diagram.
- Kindly refer to "Silvair Commissioning User Manual" for further pairing.
- Available with Magnetic reset(Touch the top part of sensor for 5 seconds).

Technology Partner
SILVAIR

Work with Silvair



Application



Indoor Application (Warehouse/Factory)



Outdoor Application

System Overview

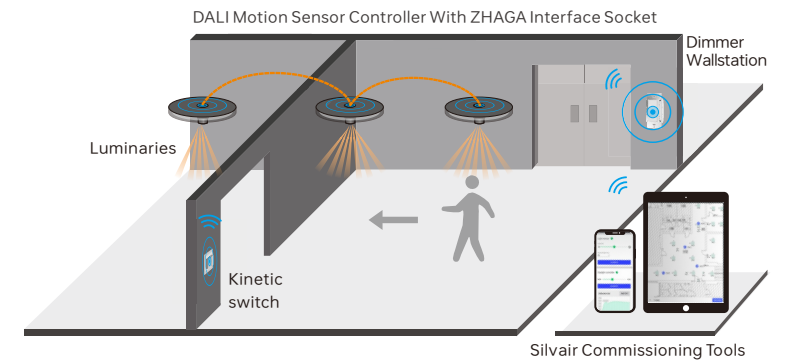

Specification

Energy Savings

- Low/High-end trimming
- Occupancy/Vacancy detection
- Auto and advanced demand response programs
- Time-of-Day dimming schedule
- Energy monitoring

Profile Configuration

- Occupancy Profile
- Vacancy Profile
- Photocell Profile
- Occupancy Profile with daylight harvesting
- Vacancy Profile with daylight harvesting

Comfort & Convenience

- Advanced occupancy detections
- Light-level stability
- Configurable dim-and-linger occupancy
- Personalized setting profile
- Work with kinetic switch keypad and dimmer wallstation
- Multi-scenes control
- Magnetic Reset

Note: Regarding the Daylight Harvesting(DH) function.

Because of the complexity of the field use environment, the accuracy of DH is affected by different installation heights and light reflectivity in the environment.

Please make sure to understand this physical error before using DH function.

Warning

- DO NOT install with power applied to device.
- DO NOT expose the device to moisture.

Detection Pattern

Coverage Side View

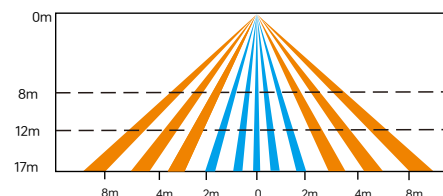

Coverage Top View

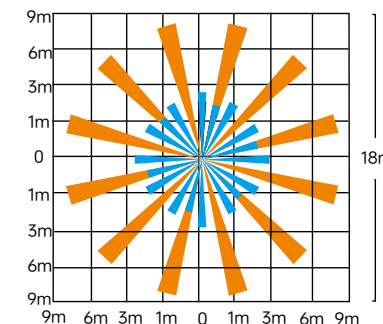

The detection area for movement sensor can be roughly divided into two parts:

- Slow movement (person moving < 1.0/s or 0.3m/s)
- Quick movement (person moving > 1.3/s or 0.4m/s)

Detection Area

Note:

- 1) Following different detection areas are based on different installation heights & patterns.
- 2) Detection Pattern is a relevant value, the performance should depends on the site conditions (installation height/ temperature/ sunlight/ humidity/ Blind area...etc)

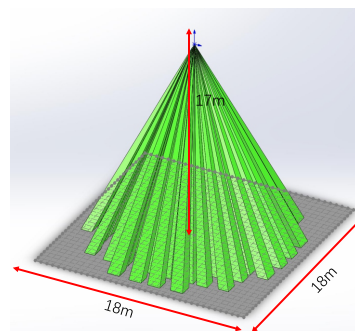

Detection pattern at 17m height

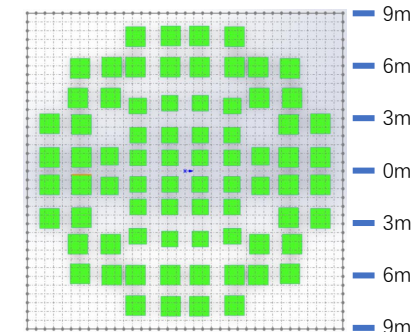

Detection pattern at 17m height



IP65 ZHAGA-BOOK 18 BLE DALI-2 Sensor Controller (With Light Sensor)

CLX-SV9033A-PIR-D-BUS (15meter version)

Wiring

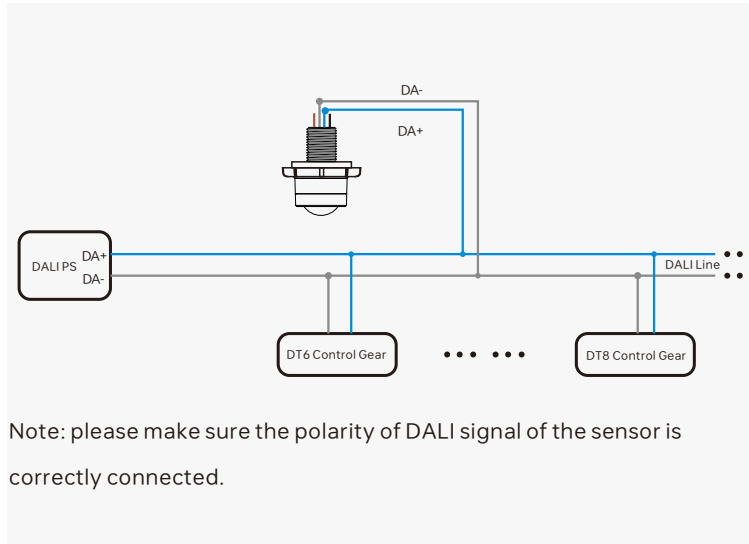

More Infos

- 1) Average Input Current: < 30mA
- 2) Standby-power consumption: < 0.5W
- 3) Power Consumption: < 1W
- 4) Max Tx Power: +8dBm
- 5) Number of connected drivers: Up to 64 control gears (Broadcast control)
- 6) Status Indicator: Red-Movement detection; Green-Network status
- 7) Detection range: $\phi 16m @ 15m$ Height @ Default sensitivity
Detection Angle: 51.6°
Operating Range (Light sensor) : 1-1000Lx
Light Sensor Accuracy: $\pm 20%$ at 3m height in 3rd party Lab.
- 8) Built-in type: IP 65, Class III, ta 45°C, tc 55°C
- 9) Storage temperature range: 0-60°C
Storage humidity: 8%-80%
- 10) Expected Lifetime: More than 5 years.
- 12) Mounting: ZHAGA BOOK 18 Socket
- 12) BT NLC certified
- 13) Nordic Chipset: nRF 52840
- 14) Zhaga Book 18 compliant based on specification



Work with Silvair



Installation Precautions

- Avoid areas with frequent temperature changes: Keep away from air conditioners, fans, refrigerators, ovens, and other objects that cause rapid temperature changes. The detection effectiveness of PIR motion sensors is closely related to temperature fluctuations, and vents or heat sources can lead to false alarms.
- Avoid areas with significant air flow.
- Avoid facing glass doors and windows directly: 1) Do not face glass doors and windows directly to avoid interference from strong light. 2) Avoid complex environments outside doors and windows, such as direct sunlight, crowds, and moving vehicles.
- Avoid installing opposite large, constantly moving objects: Large objects with significant motion can cause sudden changes in airflow within the detection area, leading to false alarms. Outdoor PIR motion sensors should not be installed opposite large trees or tall bushes.
- Avoid areas with screens, furniture, large potted plants, or other obstacles within the detection range.
- Avoid areas exposed to direct sunlight.

Accessory



9033 Series Lens cover

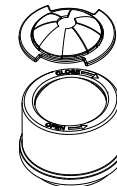

- 1) Per requirement, select the right detection pattern.
- 2) Tear off the 3M adhesive tape below, stagger it with the words on the cover, and paste it.



- 3) Done!

Statement

FCC STATEMENT

This equipment has been tested and found to comply with the limits for a Class B digital device, pursuant to Part 15 of the FCC Rules. These limits are designed to provide reasonable protection against harmful interference in a residential installation. This equipment generates uses and can radiate radio frequency energy and, if not installed and used in accordance with the instructions, may cause harmful interference to radio communications. However, there is no guarantee that interference will not occur in a particular installation. If this equipment does cause harmful interference to radio or television reception, which can be determined by turning the equipment off and on, the user is encouraged to try to correct the interference by one or more of the following measures:

- Reorient or relocate the receiving antenna.
- Increase the separation between the equipment and receiver.
- Connect the equipment into an outlet on a circuit different from that to which the receiver is connected.
- Consult the dealer or an experienced radio/TV technician for help.

This device complies with part 15 of the FCC Rules. Operation is subject to the following two conditions:

- (1) This device may not cause harmful interference, and
- (2) this device must accept any interference received, including interference that may cause undesired operation.

Changes or modifications not expressly approved by the party responsible for compliance could void the user's authority to operate the equipment.

IC STATEMENT

This device complies with Industry Canada's licence-exempt RSSs. Operation is subject to the following two conditions:

- (1) This device may not cause interference; and
- (2) This device must accept any interference, including interference that may cause undesired operation of the device.

Le présent appareil est conforme aux CNR d'Industrie Canada applicables aux appareils radio exempts de licence. L'exploitation est autorisée aux deux conditions suivantes :

- (1) l'appareil ne doit pas produire de brouillage, et
- (2) l'utilisateur de l'appareil doit accepter tout brouillage radioélectrique subi, même si le brouillage est susceptible d'en compromettre le fonctionnement.

Update Log

Date	Version	Update Content	Update by
2025-7-23	V1.2	Parameter Update	Romeo

Subject to change without notice. Please contact us if you have any questions.