

Calex Circum BCL320 MW

Description:

It adopts high brightness high quality LED as luminous body with low -voltage constant current driver, low power consumption, long lifespan, reliability and safety.

The lamp body is made of high-quality steel plate in one piece. The housing, which is elegant and stylish, is made of polystyrene with high-light transmittance. The special material guarantees that the color will never fade away.

The excellent design in heat dissipation ensures stable working of LED, and controls light attenuation effectively. Perfect optical design ensures soft and even light. Instant lighting, no flickering, no glaring. Free of lead, mercury and other harmful substances.

This product is widely used in shopping mall, hotel, restaurant and etc. It's an ideal replacement of traditional ceiling light products.

Notes:

- ◆ Only qualified electrician is allowed to do the installation, maintenance and inspection for safety concern. It is dangerous for non-professional operator
- ◆ Surface mounted installation only
- ◆ Do not install the product in high temperature or humid place

Installation Method:

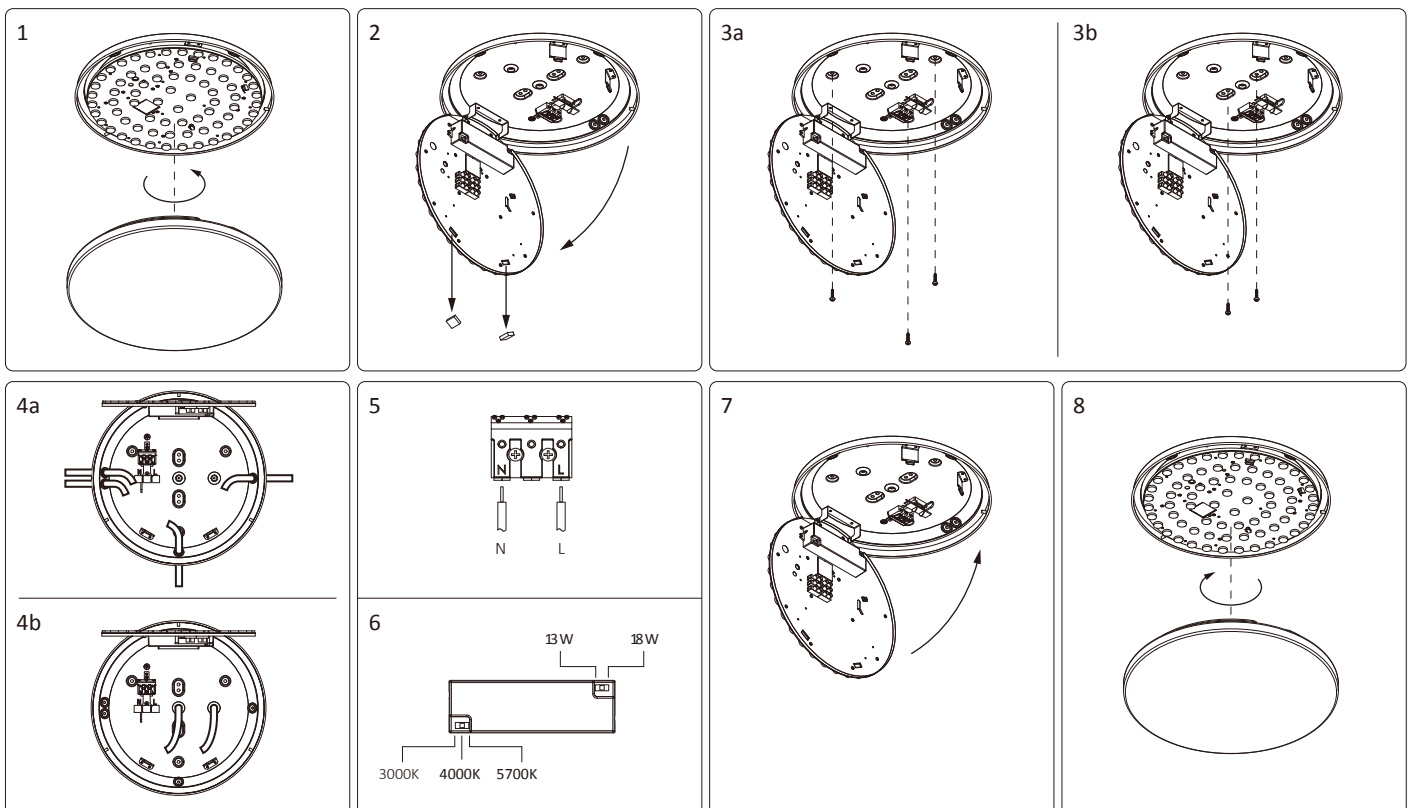

Technical Parameters:

Part No	Calex Circum BCL320 MW	
Input Voltage(VAC)	220-240V AC	
Input Current(A)	0.095	0.13
Power(W)	13W	18W
Power Factor	0.9	
Color Temperature(K)	3000K/4000K/5700K	
Luminous Flux (Lm)	1400/1550/1500	1900/2100/2000
Lifespan (hour)	100000	
Protection Rate	IP54	
Working Temperature(°C)	-20~40	
CRI (Ra)	>80	

Dimensions:

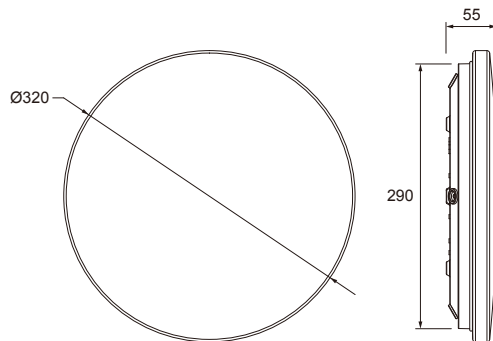

WARNING



- * Power should be cut off before installation, maintenance or inspection.
- * Please install and use the light strictly according to the instruction.
- * Do not disassemble or remold the product at will to avoid accident of electric shock or light falling.
- * For non-user replaceable light sources: "The light source contained in this luminaire shall only be replaced by the manufacturer or his service agent or a similar qualified person."
- *The symbol of the crossed out wheeled bin indicates that product(electrical and electronic equipment) should not be placed in municipal waste. Please cheek local regulations for disposal of electronic products
- *The luminaire needs to be configured by the qualified person.",The cross-sectional area of the power cord shall be at least 0.75 mm² ; for indoor use only.

1. Features



1. Conform to new ERP standards; low stand-by power.
2. 5.8GHz microwave license-free ISM wave band; bulk order are compliant with RED approval.
3. Compact size design, can be built-in most of light fixtures.
4. Simple to operate: adjusting DIP switches to change detection area, hold time, daylight sensor and other parameters.
5. Input and output terminals are convenient for connecting.

2. Parameter

Input	Voltage Range	220-240Vac 50/60Hz		
	Rated Voltage	230Vac		
	Stand-by Power	≤0.1W		
	Surge Test	1KV(L/N, EN61000-4-5)		
Output	Working Mode	ON/OFF		
	Type of Load	Inductive or Resistive Load		
	Load Capacity	200W@230Vac(Inductive Load), 400W @230Vac(Resistive Load)		
	Max. Surge Capacity	20A (50% Ipeak, twidth =500uS, 230Vac full load, cold start); 40A (50% Ipeak, twidth =200uS, 230Vac, full load, cold start)		
Sensor Parameters	Operating Frequency	5.8 GHz ±75 MHz, ISM Wave Band		
	Transmitting power	1mW Max		
	Hold time	5S/30S/1min/3min/5min/10min/20min/30min		
	Detection	100%/75%/50%/25%		
	Daylight	Normal Daylight Sensor	2Lux/10Lux/25Lux/50Lux/Disable (Ambient diffusion status)	
	Detection radius (100% detection area)	Ceiling Mounting at 3m height: 0.3m/S ≥3.5m, 1m/S ≥2.5m Wall Mounting at 2m height: 0.3m/S ≥8m, 1m/S ≥4m		
	Mounting Height	Typical Value: 3m (4m Max)		
	3db Beam Angle	84°@XZ filed		
		108°@YZ field		
	Operating Temperature	-20°C~60°C		
Storage Temperature	-40°C~80°C Humidity: ≤85%(Non-condensing)			
Certificate Standards	Safety Standards	EN61058-1-2, EN61058-1		
	EMC Standards	EN61058-1, EN61000-3-2, EN61000-3-3, EN62479 EN301489-1, EN55015, EN300440		
	Environmental Requirement	Compliant to RoHS		
	Certificate	CE, RED, TUV		

Others	Wiring	Press-in Type Terminals, wire diameter:0.75-1.5mm ²
	IP Rating	IP20
	Protection Class	Class II
	Installation	Built-in
	Dimension	61.0*29.0*25.0mm
	Package	Bubble bag+Clapboard + Carton(K=A)
	Net Weight	25.2g
	Lifetime	5 years warranty @Ta 230V full load

3. Function

(1) ON/OFF Function

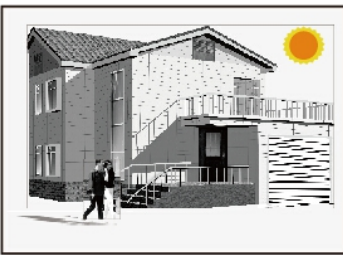

- ① With sufficient ambient light, the light will not be switched on even if with motion signal.



- ② With insufficient ambient light, the sensor switches on the light when motion is detected.



- ③ After elapse of hold time, the sensor switches off the light when no motion is detected.

Setting daylight sensor to “disable” or ambient brightness is lower than the preset daylight sensor value, when detecting moving signals sensor starts working and light will turn on. When hold time ends, light will turn off.

(2) Override Function

Light will constantly remain on after continuously turning on and off light three times in two second. Recover sensing function when power on again.

4. Dimension (mm)

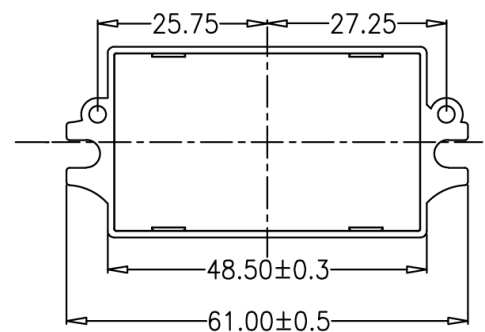
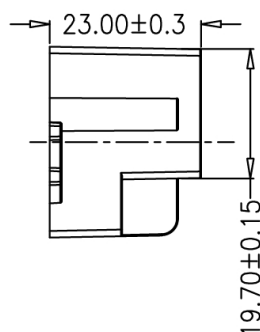
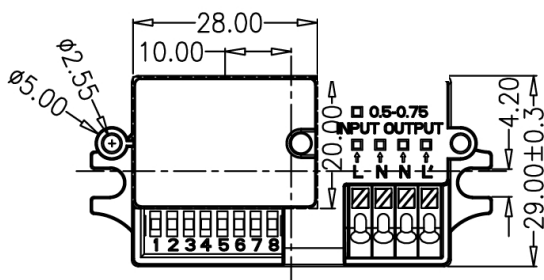
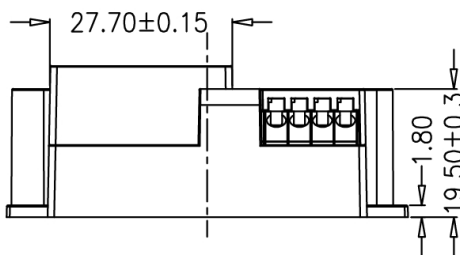

5. Structure

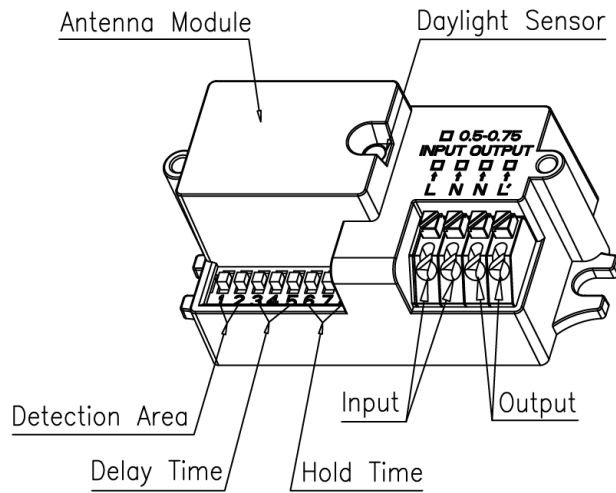

6. DIP Switch Setting

1) Detection Area

	1	2	
I	ON	ON	100%
II	ON	-	75%
III	-	ON	50%
IV	-	-	25%

2) Hold Time

	3	4	5	
I	ON	ON	ON	5S
II	ON	ON	-	30S
III	ON	-	ON	1min
IV	ON	-	-	3min
V	-	ON	ON	5min
VI	-	ON	-	10min
VII	-	-	ON	20min
VIII	-	-	-	30min

3) Sensor

	6	7	8	
I	ON	ON	ON	2Lux
II	ON	ON	-	10Lux
III	-	ON	-	25Lux
IV	ON	-	-	50Lux
V	-	-	-	Disable*

*Setting "Disable", sensor turns light when detecting moving object whether the daylight brightness is enough or not.

*Daylight thresholds are typical values that are measured on a sunny day without shadow and in an ambient light diffuse reflection status.

7. Radiation Pattern

Wall Mounting Height: 2m
Detection Area:
100%/75%/50%/25%

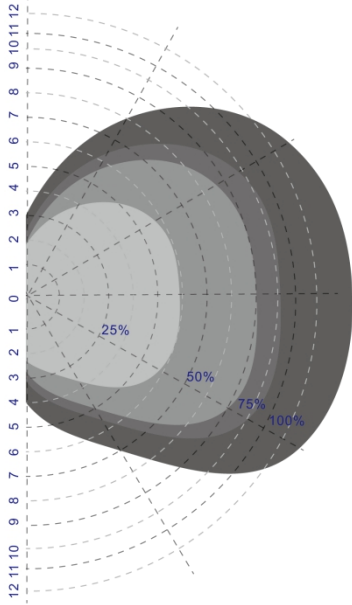

Normal moving (Speed: 1m/s)

Ceiling Mounting Height: 3m
Detection Area:
100%/75%/50%/25%

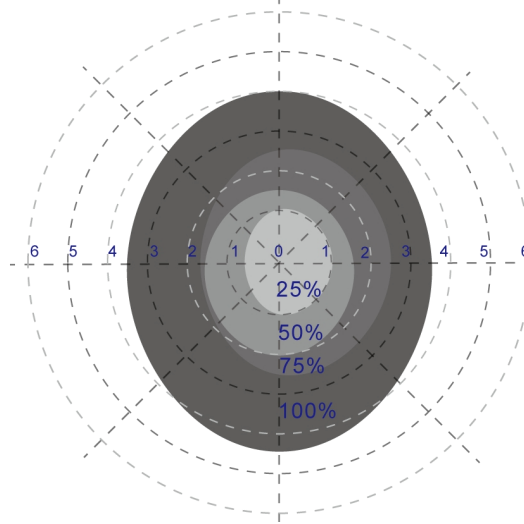

Normal moving (Speed: 1m/s)

Ceiling Mounting Height: 4m
Detection Area:
100%

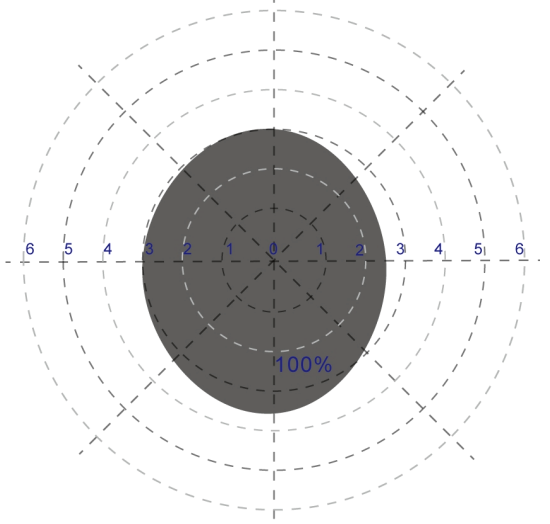

Normal moving (Speed: 1m/s)

*When installed at 4m mounting height, sensor with 75%/50%/25% detection area is unable to detect motion signals.

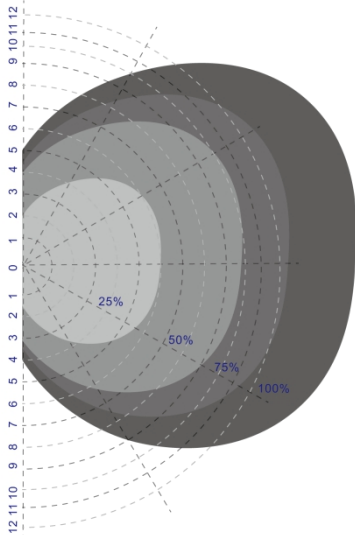

Slow moving (Speed 0.3m/s)

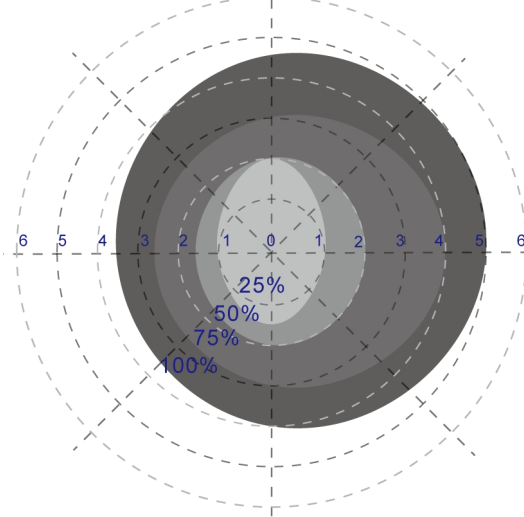

Slow moving (Speed 0.3m/s)

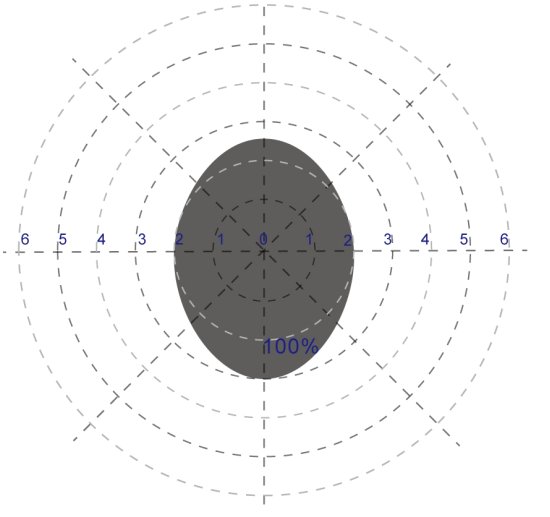

Slow moving (Speed 0.3m/s)

*When installed at 4m mounting height, sensor with 75%/50%/ 25% detection area is unable to detect motion signals.